

Bauobjekt	Tel. - Polier
Lieferadresse	Tel.
Bauunternehmer	Tel.
Architekt	Fax: 056 648 41 18 HBT-ISOL AG Postfach 5620 Bremgarten 2
Ingenieur	
Lieferdatum	
Ausgefüllt durch	
Materialliste-Nr.	Plan-Nr.
Der Besteller	
Stempel und Unterschrift	Datum

Folgende Produkte werden hiermit bestellt:

02300 Deckenlager ISODEFO						
Lieferung in Meterstreifen mit Allwetter-Klettverschluss						
	Bestell-Nr.	Typ	Dicke	Breite	Einheit	Bestell-Menge
	2310.066.	ISODEFO-10-R+S	10.0 mm mm	m ¹	
	2310.066.	ISODEFO-10-R+S	10.0 mm mm	m ¹	
	2320.050.	ISODEFO-10-R-1050	10.0 mm mm	m ¹	
	2320.050.	ISODEFO-10-R-1050	10.0 mm mm	m ¹	
	2330.075.	ISODEFO-10-R-1075	10.0 mm mm	m ¹	
	2330.075.	ISODEFO-10-R-1075	10.0 mm mm	m ¹	
Beispiel	1 2 0	ISODEFO-10-R+S	10.0 mm	...1.2.0... mm	m ¹	25

Lieferung in Meterstreifen mit Klebeband						
	Bestell-Nr.	Typ	Dicke	Breite	Einheit	Bestell-Menge
	2311.066.	ISODEFO-10-R+S	10.0 mm mm	m ¹	
	2311.066.	ISODEFO-10-R+S	10.0 mm mm	m ¹	
	2321.050.	ISODEFO-10-R-1050	10.0 mm mm	m ¹	
	2321.050.	ISODEFO-10-R-1050	10.0 mm mm	m ¹	
	2331.075.	ISODEFO-10-R-1075	10.0 mm mm	m ¹	
	2331.075.	ISODEFO-10-R-1075	10.0 mm mm	m ¹	
Beispiel	2331.066. ...1.2.0...	ISODEFO-10-R+S	10.0 mm	...1.2.0... mm	m ¹	25

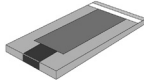
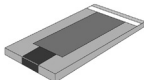

Bauobjekt	Tel. - Polier
Lieferadresse	Tel.
Bauunternehmer	Tel.
Architekt	
Ingenieur	
Lieferdatum	
Fax: 056 648 41 18 HBT-ISOL AG Postfach 5620 Bremgarten 2	
Ausgefüllt durch	
Materialliste-Nr.	Plan-Nr.
Der Besteller	
Stempel und Unterschrift	Datum

Folgende Produkte werden hiermit bestellt:

Zusatzangebote Deckenlager ISODEFO

Meterstreifen mit Allwetter-Klettverschluss, Dicke 10.0 mm

Meterstreifen mit Klebeband, Dicke 10.0 mm

Exzentrisches Lager
(thermisch dämmendes Mauerwerk)

Exzentrisches Lager
(kompaktes Mauerwerk)

2-Schalenger
(eine Schale tragend)

2-Schalenger
(beide Schalen tragend)

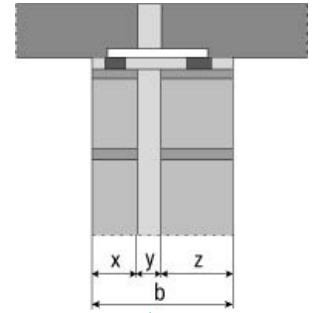
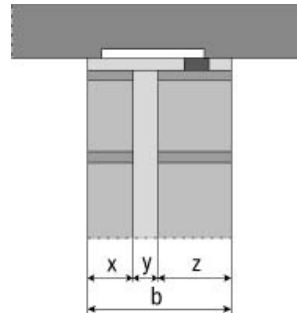
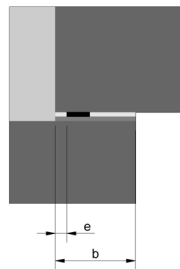
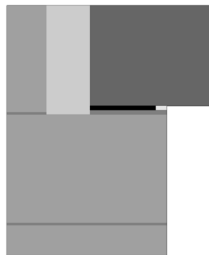

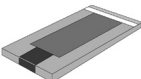
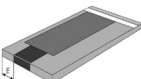
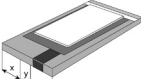
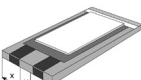
Lager-Typ		Einheit	Bestell-Menge
Exzentrisches Lager (thermisch dämmendes Mauerwerk)	Lagerbreite in mm Kernbreite in mm		
 ISODEFO-10-175-E	175 150	m ¹	
ISODEFO-10-200-E	200 150	m ¹	
ISODEFO-10-240-E	240 190	m ¹	
ISODEFO-10-.....-E	m ¹	
Exzentrisches Lager (kompaktes Mauerwerk)	Abmessung		
 ISODEFO-10-.....	Breite mm, e mm	m ¹	
ISODEFO-10-.....	Breite mm, e mm	m ¹	
ISODEFO-10-.....	Breite mm, e mm	m ¹	
2-Schalenger (eine Schale tragend)			
 ISODEFO-10-.....	Breite = x mm + y mm + z mm	m ¹	
ISODEFO-10-.....	Breite = x mm + y mm + z mm	m ¹	
ISODEFO-10-.....	Breite = x mm + y mm + z mm	m ¹	
2-Schalenger (beide Schalen tragend)			
 ISODEFO-10-.....	Breite = x mm + y mm + z mm	m ¹	
ISODEFO-10-.....	Breite = x mm + y mm + z mm	m ¹	
ISODEFO-10-.....	Breite = x mm + y mm + z mm	m ¹	



Bauobjekt	Tel. - Polier
Lieferadresse	Tel.
Bauunternehmer	Tel.
Architekt	Fax: 056 648 41 18 HBT-ISOL AG Postfach 5620 Bremgarten 2
Ingenieur	
Lieferdatum	
Ausgefüllt durch	
Materialliste-Nr.	Plan-Nr.
Der Besteller	
Stempel und Unterschrift	Datum

Folgende Produkte werden hiermit bestellt:

Fortsetzung Zusatzangebote Deckenlager ISODEFO

Lieferung in Meterstreifen mit Allwetter-Klettverschluss, Dicke 10.0 mm

Radiuslager, zentrisch

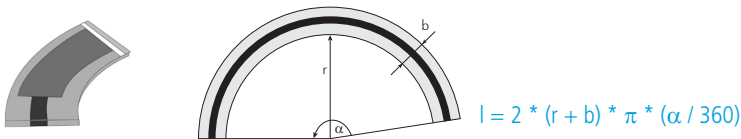

Typ	Breite b	Radius innen r	Winkel α	Bogenlänge l	Einheit	Bestell- Menge
ISODEFO-10- mm mm ° mm	Stk.	
ISODEFO-10- mm mm ° mm	Stk.	
ISODEFO-10- mm mm ° mm	Stk.	

Beispiel

ISODEFO-10- R+S.....	..200.. mm	..1000.. mm	..90.. °	..1'885.. mm	Stk.	25
----------------------	------------	-------------	----------	--------------	------	----

Radiuslager, exzentrisch

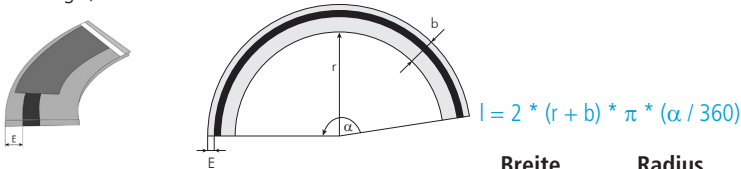

Typ	Breite b	Radius innen r	Winkel α	Bogenlänge l	Mass E	Einheit	Bestell- Menge
ISODEFO-10- mm mm ° mm mm	Stk.	
ISODEFO-10- mm mm ° mm mm	Stk.	
ISODEFO-10- mm mm ° mm mm	Stk.	